

# PRO560SL/SLE Series

## Mechanical Bearing, Ball-Screw Stage

Improved second-generation design

High-performance in a cost-effective package

Rugged mechanical construction

Optional linear encoder

12 models with travels from 300 mm to 1000 mm

Vacuum and cleanroom versions available

Available with built-in ThermoComp™ for high-performance in changing environments

The PRO560SL and PRO560SLE are Aerotech's second-generation PRO560 stage designs with many improvements and added features. Enhanced positioning specifications coupled with competitive pricing make the PRO560SL/SLE stage the ideal choice for both medium and high-performance applications. The design is similar to the PRO280SL/SLE series, providing additional load capacity and stiffness with a wider cross-section.

### Rugged Mechanical Construction

A long-life recirculating linear guide bearing system and a low-friction sealing solution make the PRO560SL/SLE an attractive solution for industrial applications such as laser machining. The basic external construction of the PRO560SL/SLE design provides protection from debris while the side-seals prevent dirt and particulates from entering the stage. The curved hard-cover design provides a natural shape that prevents excessive debris from collecting on the stage.

### Linear Encoder Option

For applications requiring direct-metrology of the output carriage, the PRO560SLE integrates a direct linear encoder that is protected by the stage sealing system. Amplified sine, digital TTL output, and absolute encoders are available as standard options for linear feedback.

### Design and Integration Flexibility

The PRO560SL/SLE is designed with many standard features and options that make the design incredibly flexible and allow it to be easily tailored to a specific application. The PRO560SL/SLE is available in

### PRO Series Gen II

Up to:

98% Higher Resolution

46% Better Repeatability

40% Reduction in Error Motions

33% Improved Accuracy

Available with

ThermoComp™



The PRO560SL-300 is one of 12 models in the PRO560SL/SLE series.

12 different models with travels ranging from 300 mm to 1000 mm and speeds up to 220 mm/s.

The base mounting holes are accessible from the outside of the stage allowing for easy mounting. Standard mounting holes for both English and metric optical tables are present in all travels. The tabletop is available with both English and metric mounting patterns and can be ordered with brush attachments to clear any debris that may collect on the stage hard cover. Tabletops with hole patterns that allow the direct attachment of Aerotech's ADRS, ACS-LP, ADRT, ACS, ALAR, and AGR rotary stages are also available.

Aerotech BM or BMS series brushless servomotors are available with a variety of encoder options providing net electronic resolutions ranging from 0.5  $\mu\text{m}$  down to sub-nm. A holding brake can be added to the motor for vertical applications. A motor foldback kit is available for space-constrained applications to reduce the overall stage length.

The PRO560SL/SLE series is also available with cleanroom preparation and vacuum versions.

### Accurate Positioning with ThermoComp

Temperature changes and thermal effects are some of the largest error sources in precision machines, particularly in ball-screw-driven mechanics due to self-heating. All PRO series stages are available with Aerotech's ThermoComp feature, an embedded temperature compensation unit that guarantees accurate positioning not only in variable temperature environments, but during extended use of ball-screw-driven stages. Using ThermoComp protects your process from real-world positioning conditions even in extreme industrial settings.

# PRO560SL/SLE Series SPECIFICATIONS

Mechanical Specifications			PRO560SL/SLE					
Travel			300	400	500	600	800	1000
Accuracy <sup>(1)</sup>	SL	Standard	±9.5 µm	±11 µm	±13 µm	±15 µm	±17 µm	±18 µm
		Calibrated	±1.5 µm	±1.5 µm	±2 µm	±2 µm	±2.5 µm	±3 µm
	SLE	Standard	±10 µm	±12 µm	±14 µm	±15.5 µm	±17 µm	±18 µm
		Calibrated	±1 µm	±1 µm	±1.5 µm	±1.5 µm	±1.5 µm	±1.5 µm
Resolution (Min. Incremental Motion)		SL	0.1 µm <sup>(2)</sup> ; 1.0 µm <sup>(3)</sup>					
		SLE	0.05 µm (-E1/-E3 Encoder); 0.2 µm (-E2 Encoder); 1.0 µm (-E4 Encoder)					
Bidirectional Repeatability <sup>(1)</sup>		SL	±1 µm	±1 µm	±1 µm	±1 µm	±1 µm	±1 µm
		SLE	±0.5 µm	±0.5 µm	±0.5 µm	±0.5 µm	±0.75 µm	±0.75 µm
Horizontal Straightness <sup>(1)</sup>			±3 µm	±4 µm	±5 µm	±6 µm	±7 µm	±8.5 µm
Vertical Straightness <sup>(1)</sup>			±3µm	±4 µm	±5 µm	±6 µm	±7 µm	±8.5 µm
Pitch			49 µrad (10.1 arc sec)	60 µrad (12.4 arc sec)	70 µrad (14.4 arc sec)	78 µrad (16.1 arc sec)	90 µrad (18.6 arc sec)	110 µrad (22.7 arc sec)
Roll			39 µrad (8.0 arc sec)	44 µrad (9.1 arc sec)	53 µrad (10.9 arc sec)	58 µrad (12.0 arc sec)	73 µrad (15.1 arc sec)	87 µrad (17.9 arc sec)
Yaw			49 µrad (10.1 arc sec)	60 µrad (12.4 arc sec)	70 µrad (14.4 arc sec)	78 µrad (16.1 arc sec)	90 µrad (18.6 arc sec)	110 µrad (22.7 arc sec)
Maximum Speed <sup>(4)</sup>			220 mm/s					140 mm/s
Maximum Acceleration <sup>(4)</sup>			Function of Motor, Amplifier Selection, Payload, and Maximum Axial Load					
Load Capacity <sup>(5)</sup>		Horizontal	150 kg					
		Vertical (Axial)	70 kg					
		Side	150 kg					
Moving Mass (w/ Tabletop)		SL	24.6 kg					
		SLE	24.8 kg					
Stage Mass (No Motor)		SL	63.7 kg	68.6 kg	73.5 kg	78.4 kg	88.2 kg	98.0 kg
		SLE	65.5 kg	70.7 kg	75.9 kg	81.0 kg	91.4 kg	101.8 kg
Material			Anodized Aluminum					
MTBF (Mean Time Between Failure)			20,000 Hours					

Notes:

1. Certified with -PL1/-PL2 options.
2. Achieved with Aerotech rotary motor with amplified sine encoder.
3. Achieved with Aerotech rotary motor with 2500 cnts/rev digital encoder.
4. Requires the selection of an appropriate amplifier with sufficient voltage and current.
5. Axis-orientation for on-axis loading is listed.
6. Specifications are for single-axis systems measured 25 mm above the tabletop. Performance of multi-axis systems is payload and workpoint dependent. Contact factory for multi-axis applications.
7. Specifications listed are non-foldback kit options. Contact factory for specifications when a foldback kit (-FBx) is used.

Electrical Specifications	
Drive System	Brushless Rotary Servomotor
Feedback (Linear Encoder – SLE Version Only)	Incremental – 1 Vpp and TTL (0.1 µm & 0.5 µm) Output Absolute - EnDat 2.2
Feedback (Rotary Encoder)	Incremental – 1000 lines/rev (1 Vpp) and 2500 lines/rev (TTL)
Maximum Bus Voltage	320 VDC
Limit Switches	5 V, Normally-Closed

Recommended Controller		
Multi-Axis	A3200	Ndrive HLe/Ndrive CP/Ndrive HPe/Npaq
	Ensemble	Ensemble HLe/Ensemble CP/Ensemble HPe
Single Axis	Soloist	Soloist CP/Soloist HPe

## PRO560SL/SLE Series SPECIFICATIONS

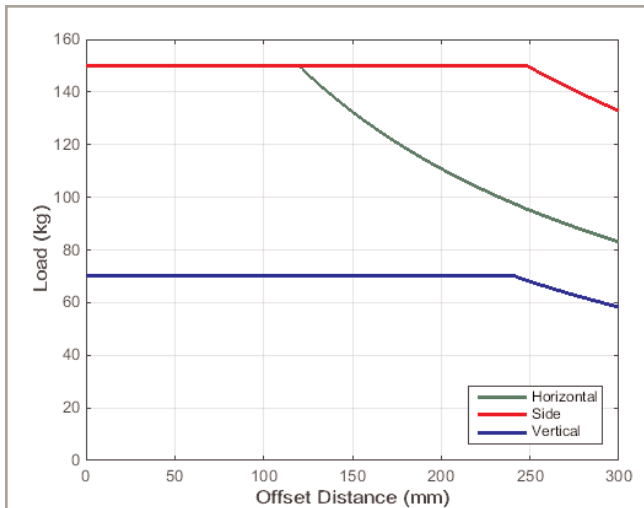

Cantilevered load capability of the PRO560SL/SLE.

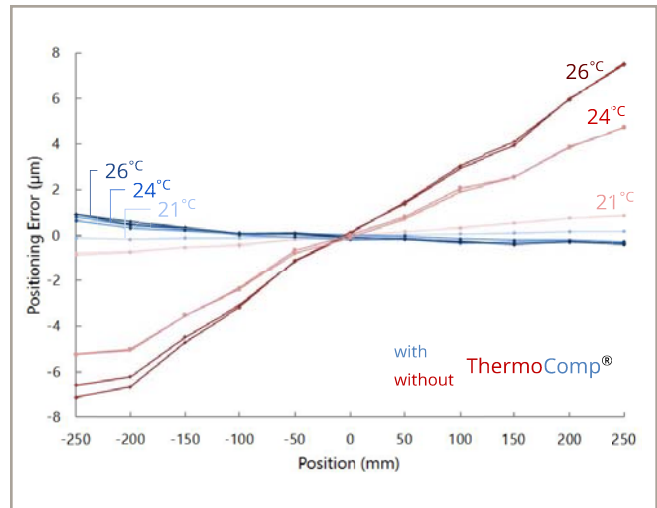

Measurement data showing successful compensation of thermal related positioning errors at several temperatures using the ThermoComp feature. Results are typical of stage performance with and without ThermoComp.

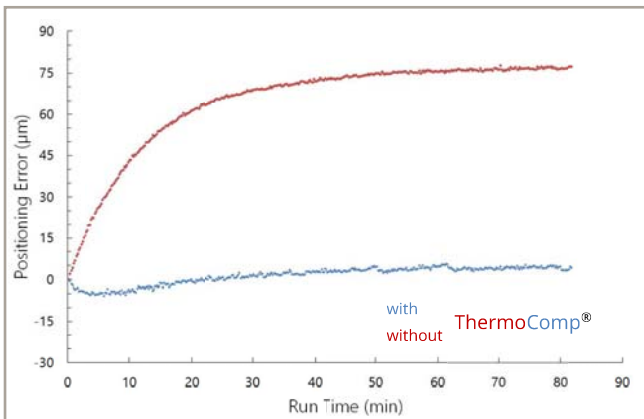

Measurement data showing successful compensation of internal heating related positioning errors during prolonged operation of a ball screw stage using the ThermoComp feature. Results are typical of ball screw stage performance with and without ThermoComp.

# PRO560SL/SLE Series DIMENSIONS

## PRO560SL

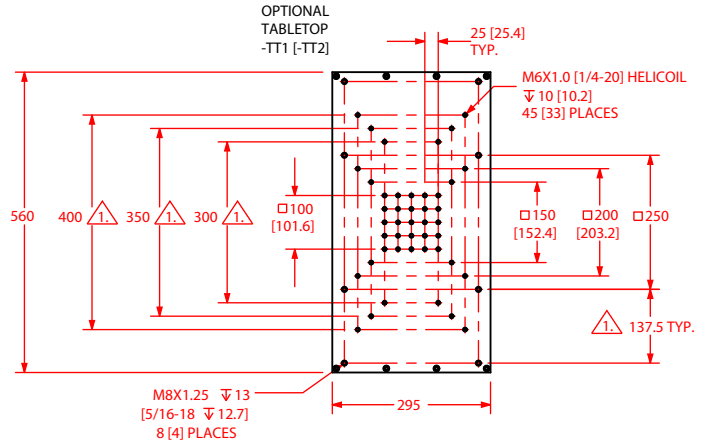
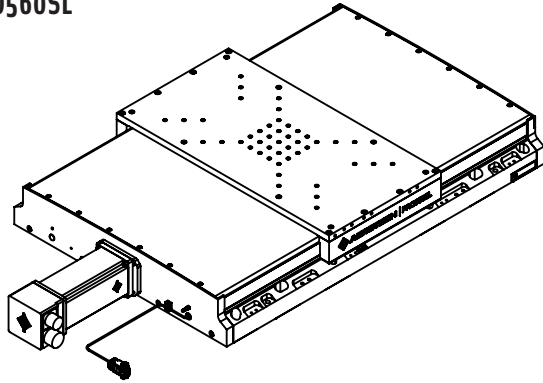

AIR PURGE FITTING  
6MM OR 1/4 IN OD TUBING

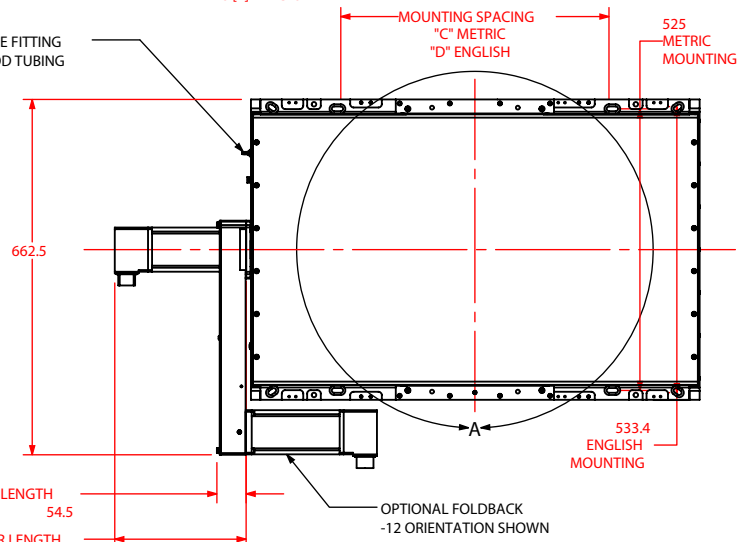

MOTOR LENGTH  
-M1, -M3, -M5, -M7 = 244.9  
-M2, -M4, -M6, -M8 = 300.5

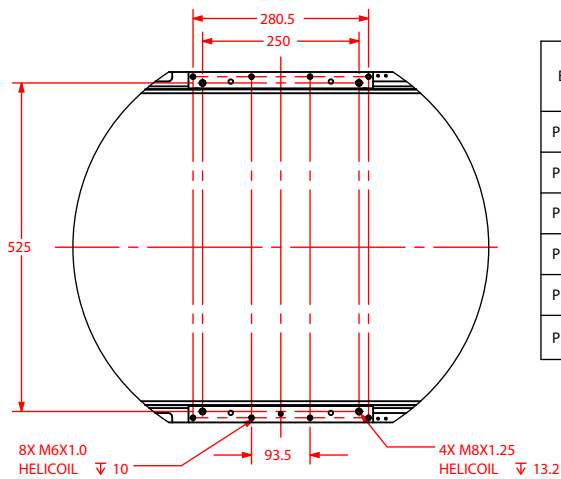
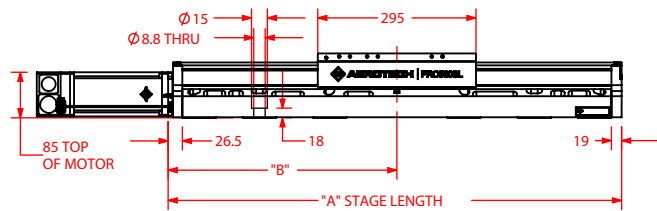
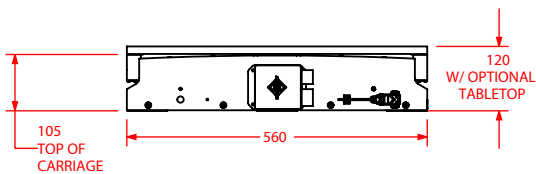

DETAIL A  
CARRIAGE MOUNTING HOLES

BASIC MODEL	NOMINAL TRAVEL	ELEC LIMIT TRAVEL	MECH LIMIT TRAVEL	A	B	C	D
PRO560SL-0300	304.8	312.4-317.2	340.4	745.5	376.5	250, 500-525	254
PRO560SL-0400	406.4	414-418.8	440.4	845.5	426.5	250, 500-525, 750	254, 762
PRO560SL-0500	508	515.6-520.4	540.4	945.5	476.5	250, 500-525, 750	254, 762
PRO560SL-0600	609.6	617.2-622	640.4	1045.5	526.5	250, 500-525, 750	254, 762
PRO560SL-0800	812.8	820.4-825.2	840.4	1245.5	626.5	250, 500-525, 750	254, 762
PRO560SL-1000	1016	1023.6-1028.4	1040.4	1445.5	726.5	250, 500-525, 750, 1250	254, 762, 1193.8

NOTES:

△ FEATURE AVAILABLE ONLY ON -TT1, TT4 TABLETOP.

2. DIMENSIONS: MILLIMETERS.

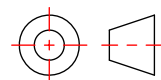

PRO560SLE

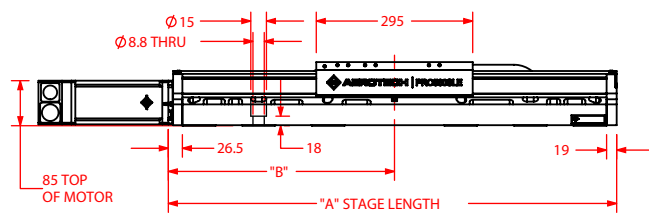
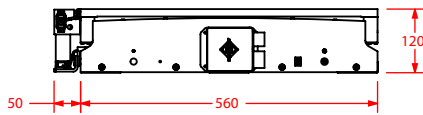
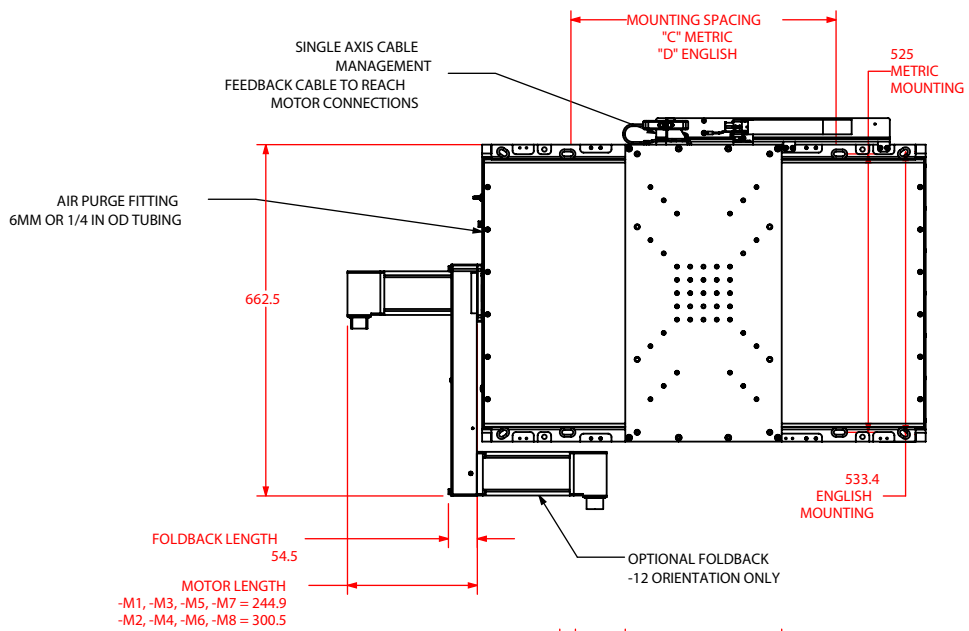
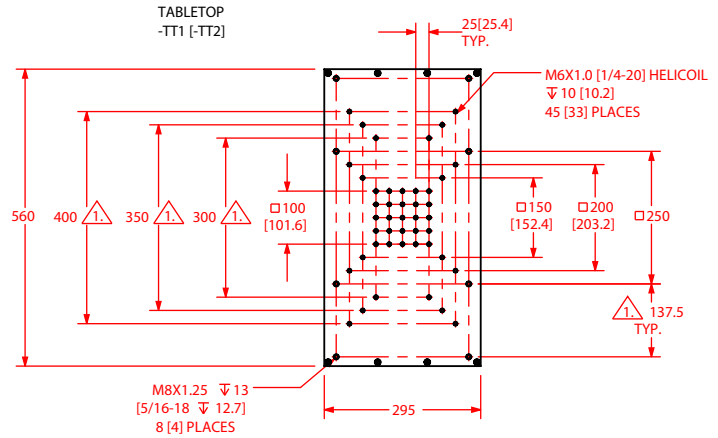
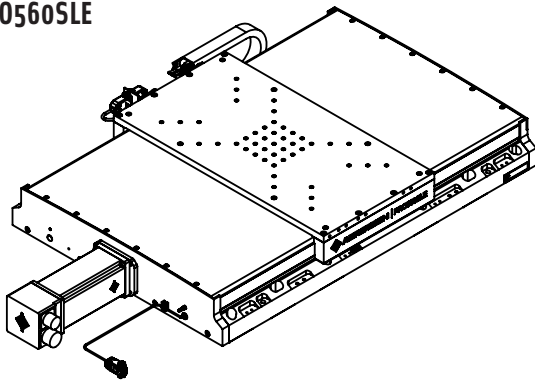

SPACE FOR  
CUSTOMER-INSTALLED  
TUBING OR CABLE  
Ø 6.5 MAX

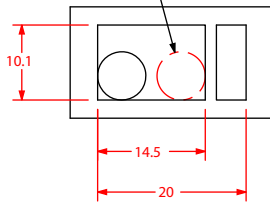

CABLE CARRIER  
CROSS SECTION

BASIC MODEL	NOMINAL TRAVEL	ELEC LIMIT TRAVEL	MECH LIMIT TRAVEL	A	B	C	D
PRO560SLE-0300	304.8	312.4-317.2	340.4	745.5	376.5	250, 500-525	254
PRO560SLE-0400	406.4	414-418.8	440.4	845.5	426.5	250, 500-525, 750	254, 762
PRO560SLE-0500	508	515.6-520.4	540.4	945.5	476.5	250, 500-525, 750	254, 762
PRO560SLE-0600	609.6	617.2-622	640.4	1045.5	526.5	250, 500-525, 750	254, 762
PRO560SLE-0800	812.8	820.4-825.2	840.4	1245.5	626.5	250, 500-525, 750	254, 762
PRO560SLE-1000	1016	1023.6-1028.4	1040.4	1445.5	726.5	250, 500-525, 750, 1250	254, 762, 1193.8

NOTES:

△ FEATURE AVAILABLE ONLY ON -TT1, -TT4 TABLETOP.

2. DIMENSIONS: MILLIMETERS.

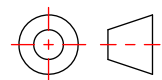

# PRO560SL/SLE Series Accessory Tabletop DIMENSIONS

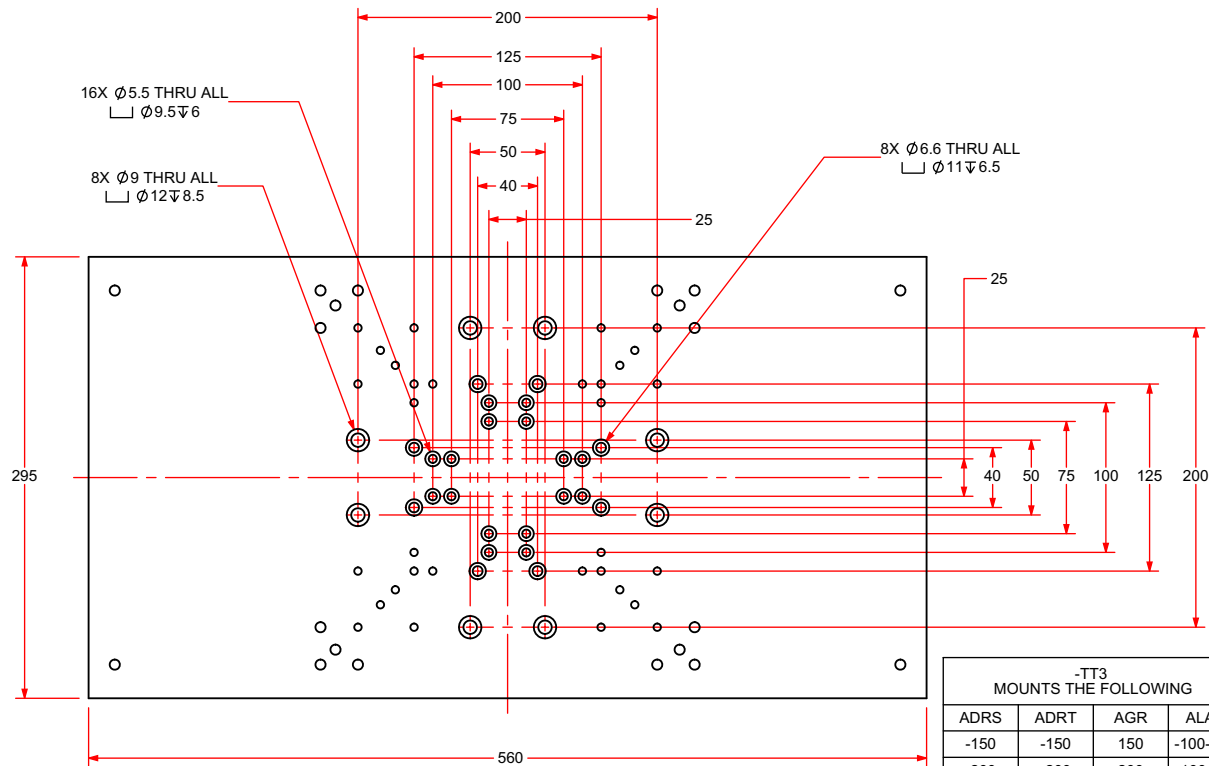
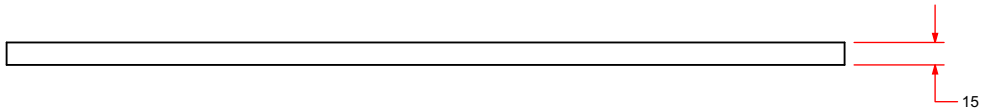
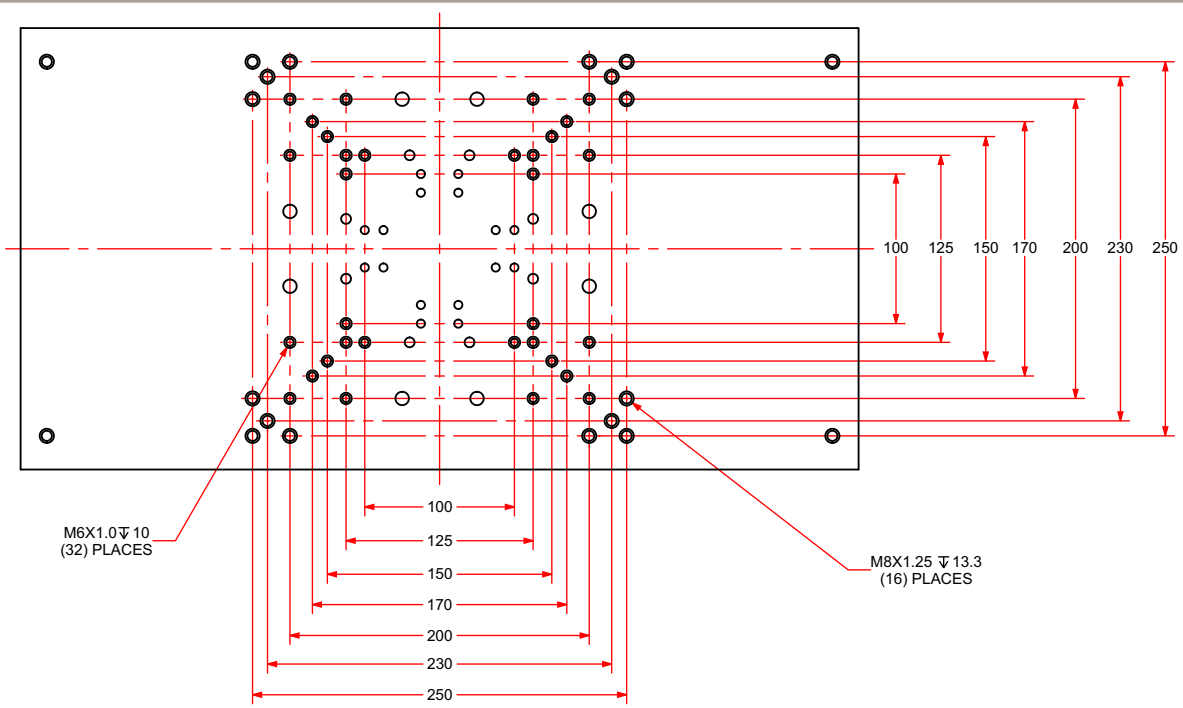

-TT3 MOUNTS THE FOLLOWING			
ADRS	ADRT	AGR	ALAR
-150	-150	150	-100-SP*
-200	-200	200	-100-LP*
	-260		

\*SIDE MOUNT NOT AVAILABLE

DIMENSIONS: MILLIMETERS

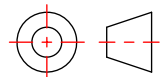

## PRO560SL/SLE Series ORDERING INFORMATION

### PRO560SL Series Linear, Ball-Screw Stage

#### Travel (Required)

-0300	300 mm travel stage
-0400	400 mm travel stage
-0500	500 mm travel stage
-0600	600 mm travel stage
-0800	800 mm travel stage
-1000	1000 mm travel stage

#### Mounting Orientation (Required)

	Normal mounting orientation
-MT1	Side-mounted or vertical orientation
-MT2	Inverted mounting orientation

#### Tabletop (Optional)

-TT1	Tabletop with metric dimension mounting
-TT2	Tabletop with English dimension mounting
-TT3	Accessory tabletop with mounting for select rotary stages
-TT4	Tabletop with metric dimension mounting and wiper brushes
-TT5	Tabletop with English dimension mounting and wiper brushes
-TT6	Accessory tabletop with mounting for select rotary stages and wipers

#### Motor (Optional)

-M1	BMS465 brushless servomotor and 2500-line TTL encoder
-M2	BMS465 brushless servomotor, 2500-line TTL encoder, and brake
-M3	BMS465 brushless servomotor and 1000-line 1 Vpp encoder
-M4	BMS465 brushless servomotor, 1000-line 1 Vpp encoder, and brake
-M5	BM500 brushless servomotor and 2500-line TTL encoder
-M6	BM500 brushless servomotor, 2500-line TTL encoder, and brake
-M7	BM500 brushless servomotor and 1000-line 1 Vpp encoder
-M8	BM500 brushless servomotor, 1000-line 1 Vpp encoder, and brake

#### Foldback (Optional)

-FB1	Foldback kit for 0.500 inch diameter shaft NEMA 34 motor
------	--

#### Motor Orientation (Optional)

-2	Bottom cable exit, optional orientation
-3	Left-side cable exit, standard orientation
-4	Top cable exit, optional orientation
-5	Right-side cable exit, optional orientation
-8	Right-side foldback, standard orientation
-12	Left-side foldback, optional orientation

#### Limits (Required)

-LI1	Normally-closed limit switches; 5 VDC with 9-Pin D connector
-LI2	Normally-open limit switches; 5 VDC with 9-Pin D connector
-LI3	Normally-closed limit switches; 24 VDC with 9-Pin D connector

#### Coupling (Optional)

-CP1	Coupling for 0.500 inch diameter shaft
------	--

#### Lifting Hardware (Optional)

-LF	Lifting hardware
-----	------------------

Note: Lifting option available on all travels. Lifting should never be ordered on the upper-axis of an XY set (only order on lower-axis).

#### ThermoComp (Optional)

-TCMP	ThermoComp integrated thermal compensation, single or lower axis (-TCMP)
-------	--

Note: An A3200 controller must be used with the -TCMP option.

## PRO560SL/SLE Series ORDERING INFORMATION

### Metrology (Required)

-PL0	No metrology performance plots
-PL1	Metrology, uncalibrated with performance plots
-PL2	Metrology, calibrated (HALAR) with performance plots

### Integration (Required)

Aerotech offers both standard and custom integration services to help you get your system fully operational as quickly as possible. The following standard integration options are available for this system. Please consult Aerotech if you are unsure what level of integration is required, or if you desire custom integration support with your system.

-TAS	Integration - Test as system Testing, integration, and documentation of a group of components as a complete system that will be used together (ex: drive, controller, and stage). This includes parameter file generation, system tuning, and documentation of the system configuration.
-TAC	Integration - Test as components Testing and integration of individual items as discrete components. This is typically used for spare parts, replacement parts, or items that will not be used or shipped together (ex: stage only). These components may or may not be part of a larger system.

### Accessories (To Be Ordered As Separate Line Item)

ALIGN-NPA	Non-precision XY assembly
ALIGN-PA10	XY assembly; 10 arc sec orthogonality. Alignment to within 7 microns orthogonality for short travel stages.
ALIGN-PA5	XY assembly; 5 arc sec orthogonality. Alignment to within 3 microns orthogonality for short travel stages.

## PRO560SLE Series Linear, Ball-Screw Stage with Direct Linear Feedback

### Direct Linear Feedback (Required)

-E1	Incremental linear encoder; 1 Vpp
-E2	Incremental linear encoder; 0.1 $\mu$ m digital TTL output
-E3	Absolute linear encoder; EnDat 2.2
-E4	Incremental linear encoder, 0.5 $\mu$ m digital TTL output

### Travel (Required)

-0300	300 mm travel stage
-0400	400 mm travel stage
-0500	500 mm travel stage
-0600	600 mm travel stage
-0800	800 mm travel stage
-1000	1000 mm travel stage

### Mounting Orientation (Required)

	Normal mounting orientation
-MT1	Side-mounted or vertical orientation
-MT2	Inverted mounting orientation

### Tabletop (Required)

-TT1	Tabletop with metric dimension mounting
-TT2	Tabletop with English dimension mounting
-TT3	Accessory tabletop with mounting for select rotary stages
-TT4	Tabletop with metric dimension mounting and wiper brushes
-TT5	Tabletop with English dimension mounting and wiper brushes
-TT6	Accessory tabletop with mounting for select rotary stages and wipers



## PRO560SL/SLE Series ORDERING INFORMATION

### Motor (Optional)

-M1	BMS465 brushless servomotor and 2500-line TTL encoder
-M2	BMS465 brushless servomotor, 2500-line TTL encoder, and brake
-M3	BMS465 brushless servomotor and 1000-line 1 Vpp encoder
-M4	BMS465 brushless servomotor, 1000-line 1 Vpp encoder, and brake
-M5	BM500 brushless servomotor and 2500-line TTL encoder
-M6	BM500 brushless servomotor, 2500-line TTL encoder, and brake
-M7	BM500 brushless servomotor and 1000-line 1 Vpp encoder
-M8	BM500 brushless servomotor, 1000-line 1 Vpp encoder, and brake

### Foldback (Optional)

-FB1	Foldback kit for 0.500 inch diameter shaft NEMA 34 motor
------	--

### Motor Orientation (Optional)

-2	Bottom cable exit, optional orientation
-3	Left-side cable exit, standard orientation
-4	Top cable exit, optional orientation
-5	Right-side cable exit, optional orientation
-8	Right-side foldback, standard orientation
-12	Left-side foldback, optional orientation

### Limits (Required)

-LI1	Normally-closed limit switches; 5 VDC with 9-Pin D connector
-LI2	Normally-open limit switches; 5 VDC with 9-Pin D connector
-LI3	Normally-closed limit switches; 24 VDC with 9-Pin D connector

### Coupling (Optional)

-CP1	Coupling for 0.500 inch diameter shaft
------	--

### Lifting Hardware (Optional)

-LF	Lifting hardware
-----	------------------

Note: Lifting option available on all travels. Lifting should never be ordered on the upper-axis of an XY set (only order on lower-axis).

### ThermoComp (Optional)

-TCMP	ThermoComp integrated thermal compensation, single or lower axis (-TCMP)
-------	--

Note: An A3200 controller must be used with the -TCMP option.

### Metrology (Required)

-PL0	No metrology performance plots
-PL1	Metrology, uncalibrated with performance plots
-PL2	Metrology, calibrated (HALAR) with performance plots

### Integration (Required)

Aerotech offers both standard and custom integration services to help you get your system fully operational as quickly as possible. The following standard integration options are available for this system. Please consult Aerotech if you are unsure what level of integration is required, or if you desire custom integration support with your system.

-TAS	Integration - Test as system Testing, integration, and documentation of a group of components as a complete system that will be used together (ex: drive, controller, and stage). This includes parameter file generation, system tuning, and documentation of the system configuration.
-TAC	Integration - Test as components Testing and integration of individual items as discrete components. This is typically used for spare parts, replacement parts, or items that will not be used or shipped together (ex: stage only). These components may or may not be part of a larger system.

### Accessories (To Be Ordered As Separate Line Item)

ALIGN-NPA	Non-precision XY assembly
ALIGN-PA10	XY assembly; 10 arc sec orthogonality. Alignment to within 7 microns orthogonality for short travel stages.
ALIGN-PA5	XY assembly; 5 arc sec orthogonality. Alignment to within 3 microns orthogonality for short travel stages.